



FRAGMENTI
COTTO

FRAGMENTI

^{IT}/Narrare lo stretto rapporto tra materia e forma contraddistingue la ricerca di Fragmenti, un nuovo progetto di superfici decorative contemporanee.

Il progetto nasce dalla passione e la follia di un gruppo di giovani ragazzi italiani.

La PASSIONE per il design e per la progettazione d'interni.

La FOLLIA di guardare oltre il materiale e la sua tradizionale interpretazione progettuale.

A volte basta poco. Non serve urlare per farsi notare.

Different eyes. Wider views.

^{EN}*Narrating the close relationship between material and shape distinguishes Fragmenti's research, a new project of contemporary decorative surface.*

The project born from the passion and the folly of some young Italian guys.

The PASSION about design and the interiors.

The FOLLY of seeing beyond the material and its traditional design interpretation.

Sometimes it doesn't take much. You don't need to scream to be noticed.

Different eyes. Wider views.

Contents

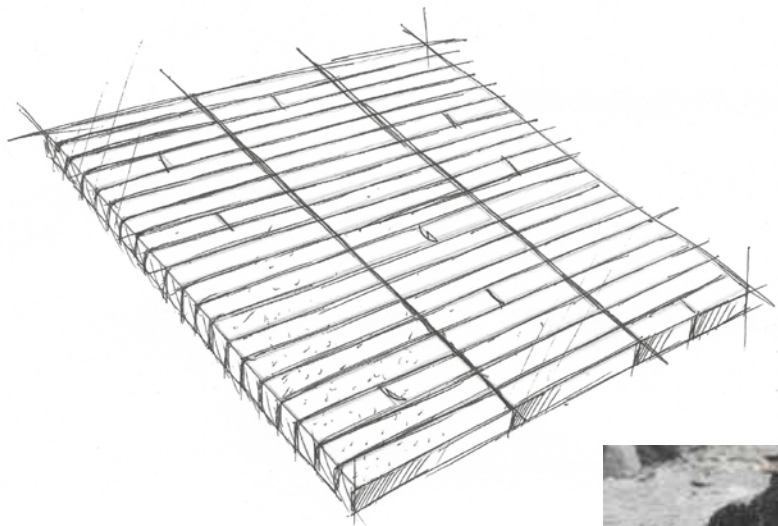

05



Intro Frammenti
Frammenti Cotto
Il Cotto di Impruneta
The Collection

p.01
p.04
p.06
p.12

Layouts
Product Specifications
Technical features
Installation and Care

p.92
p.98
p.102
p.103

Forme
contemporanee
abbracciano un
materiale dalle
radici storiche.

Contemporary lines
embrace a material
with historical roots.

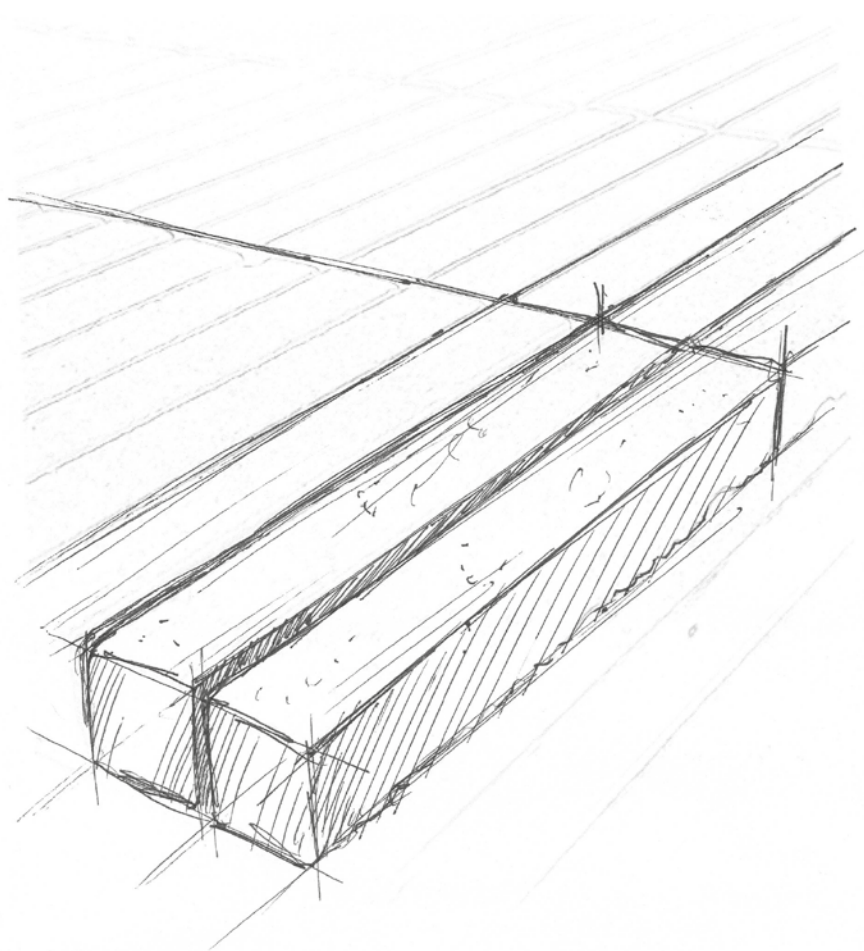

Fragmenti Cotto

IT/FRAGMENTI Cotto è una collezione di tessere di Mosaico in COTTO di IMPRUNETA dalla superficie "arrociata" ed angoli "burattati"

EN/FRAGMENTI Cotto is a program of COTTO di IMPRUNETA mosaic patterns with "arrociato" surface and "tumbled" edges.

IL COTTO DI IMPRUNETA

^{IT}La collezione affonda le sue radici nel territorio di Impruneta vicino a Firenze, nelle valli dei fiumi Ema e Greve, ricco di un argilla unica nel suo genere chiamata Galestro. E' questa argilla che conferisce al Cotto di Impruneta una colorazione caratteristica e prestazioni tecniche superiori.

^{EN}The collection has its roots in the Impruneta area near Florence, in the valleys of the Ema and Greve rivers, rich in an unique clay called Galestro. It 's thanks to this particular clay that Cotto di Impruneta has its distinctive colour and superior technical performances.



galestro clay



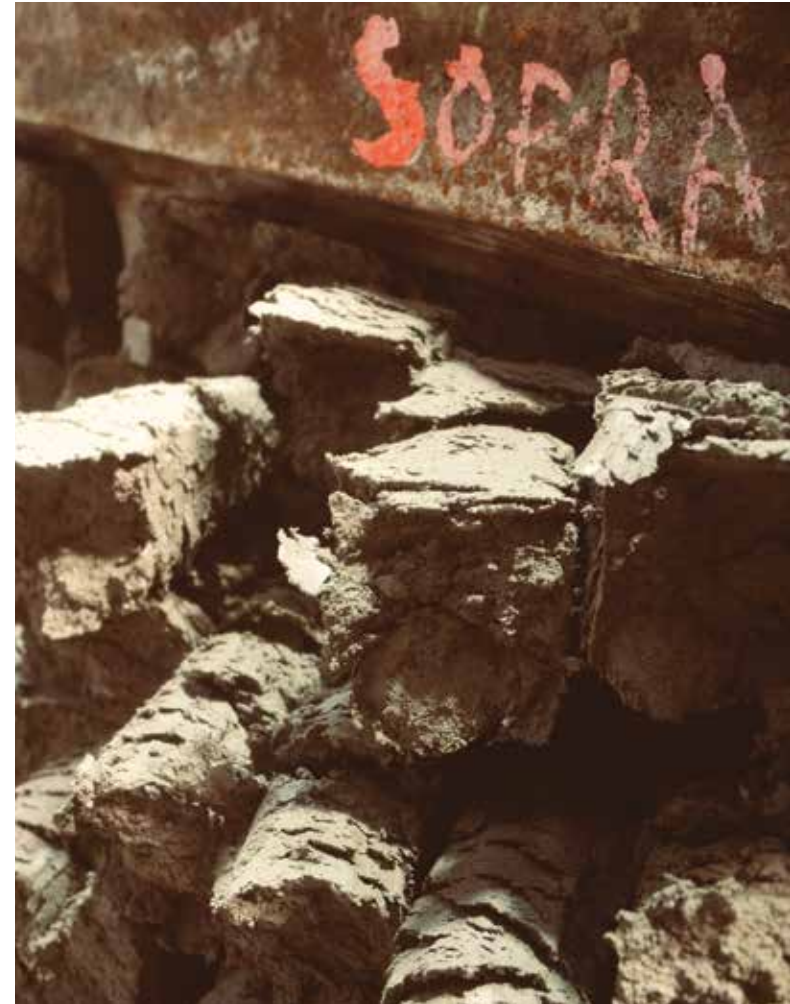

^{IT}/La lavorazione del materiale crudo con spazzole d'acciaio, detta ARROTATURA, "pulisce" il materiale dalle linee di estrusione conferendo al materiale la sua tipica superficie spazzolata.

^{EN}/The processing of the dried raw material with steel brushes, called "arrotatura", cleans the material from extrusion marks and gives it the typical cotto brushed surface.

arrotato



^{IT/}L'impasto di TERRA e ACQUA dopo essere stato degassato , trafilato e forgiato perde la sua naturale umidità mediante un processo di essiccazione ad ARIA forzata che dura fino a 42 ore.

Il FUOCO e le 72 ore di cottura a temperature prossime ai 1000 gradi forgianno la materia e gli conferiscono il carattere, la durezza e la resistenza che fanno del Cotto di Impruneta un'istituzione del made in Tuscany e del Made in Italy

^{EN/}The mixture of EARTH and WATER, after being degassed , extruded and shaped loses its natural moisture thanks to a long AIR drying process which takes up to 42 hours. The FIRE and the 72 hours of firing with temperatures close to 1000 degrees forge the material and give it the character and the strength which make Cotto di Impruneta a reference of the Made in Tuscany and Made in Italy.

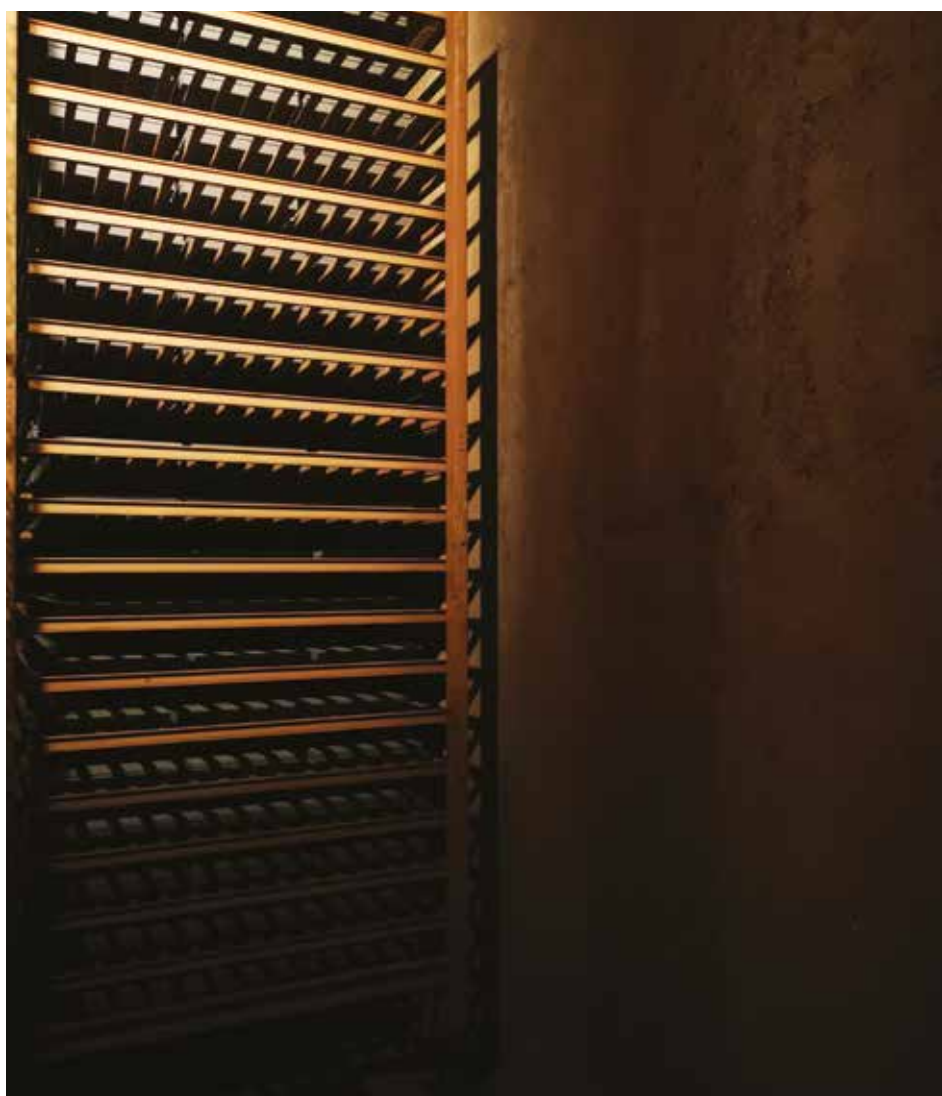

THE COLLECTION



The essence
of simplicity



Fragmenti Cotto
celebrates the
essential of the
material and the
purity of the
shapes

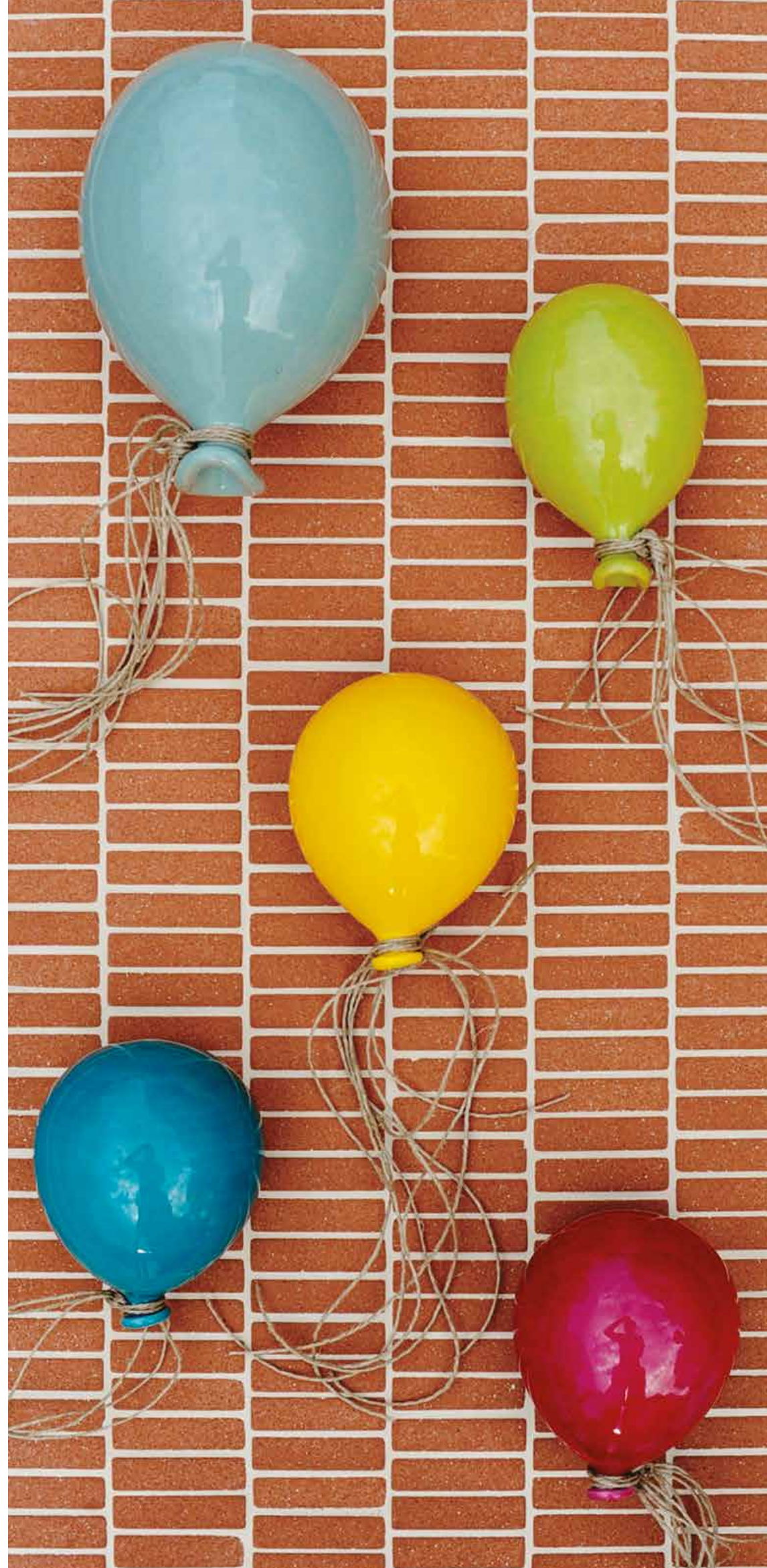

Material still matters

A close-up photograph of several rectangular stone tiles with a reddish-brown, porous, and textured surface. The tiles are arranged in a staggered pattern, with some overlapping others. The lighting is warm, highlighting the natural grain and texture of the stone. The overall appearance is that of a natural, earthy material.

**Natural
Beauty**

Natural
elements.
Contemporary
vibes.



Bathroom | FRG013148000
Lungo_01



Bathroom | FRG048298000
Bricco_02



Bathroom | Floor
FRG048148000
Bricco_01
| Wall
FRG048298000
Bricco_02



Bathroom | FRG13098000
Corto_02

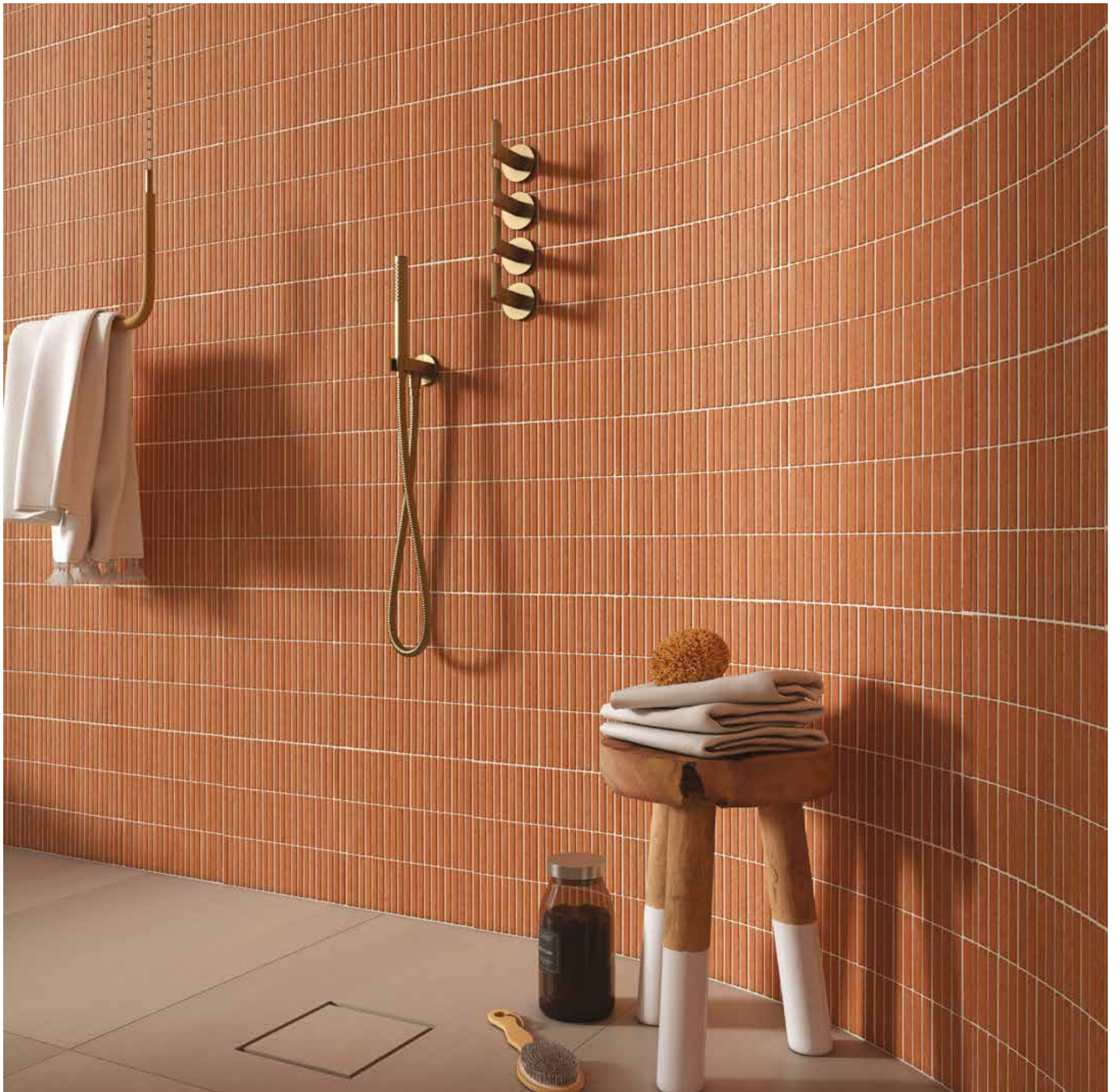

Bathroom | FRG13098000
Corto_02

Terracotta Wall Blush





Bathroom | FRG023148000
Lungo_02



Bathroom | FRG023148000
Lungo_02











Bathroom | FRG048148000
Bricco_01



Kitchen | FRG048298000
Bricco_02

**When you grout it
in black, you never
come back.**





Kitchen | FRG048298000
Bricco_02





Kitchen | FRG013048098
Corto_03







Living

FRG013148000
Lungo_01

#befrag





Living

FRG04829800
Bricco_02



Bedroom | FRG048298000
Bricco_02



**Skinny
shapes.
Classic
dreams.**



Public Space | FRG073298000
Bricco_03



Public Space | FRG048298000 | FRG073298000
Bricco_02 | Bricco_03

Don't be
shy. It
loves colours.





Public Space | FRG023148000
Lungo_02



Public Space | FRG023148000
Lungo_02

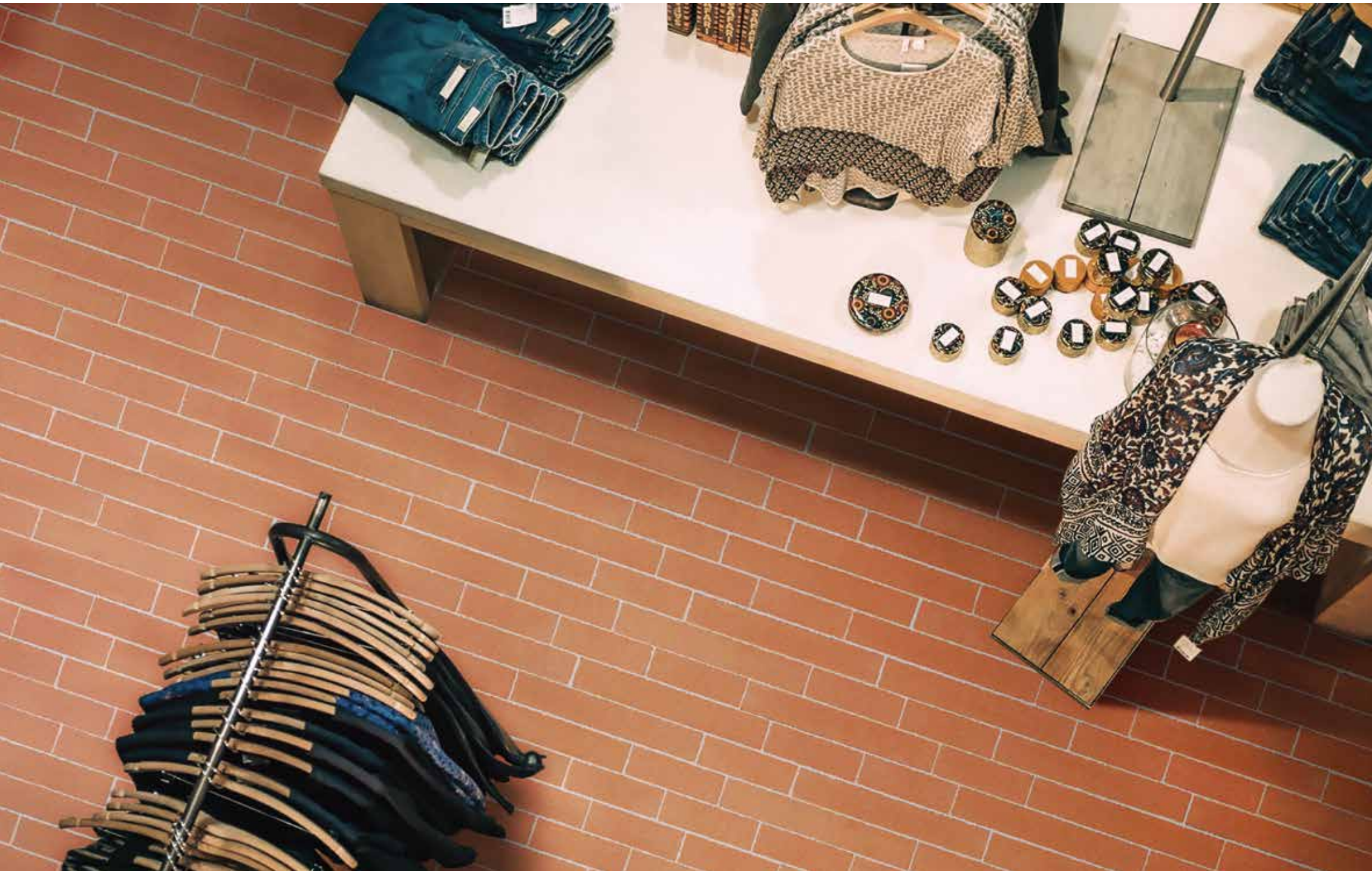

Public Space | FRG048148000
Bricco_01

FRG048298000
Bricco_02



Public Space | FRG048148000
Bricco_01



Public Space | FRG048148000
Bricco_01



ICCO

ZIOBRICCO
WINE BAR



Outdoor | FRG073298000
Bricco_03

ZIOBRICCO
WINE BAR

Outdoor | FRG073298000
Brcco_03



Outdoor

FRG023298000
Lungo_03

LevelUp



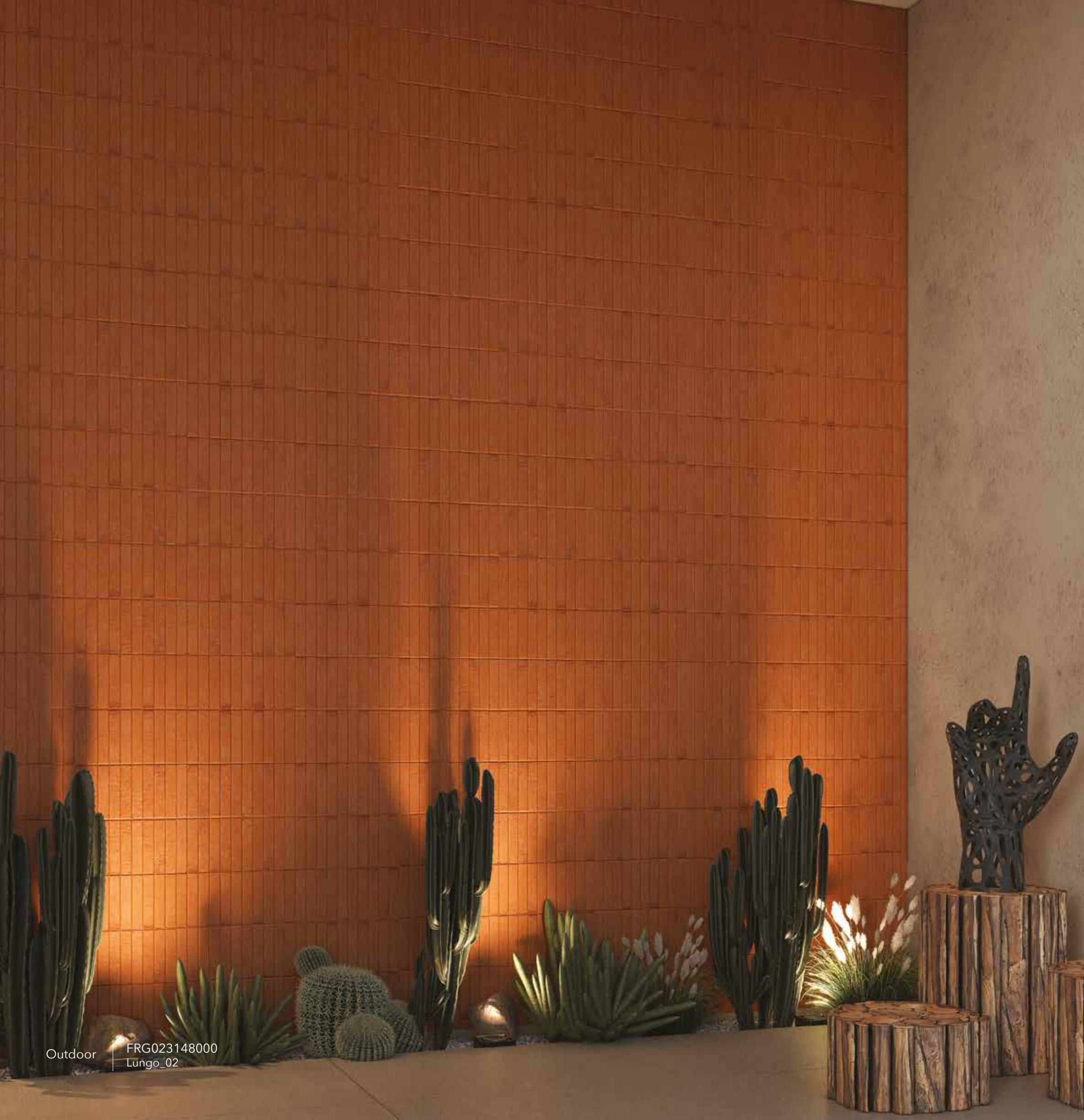

Outdoor | FRG023148000
Lungo_02

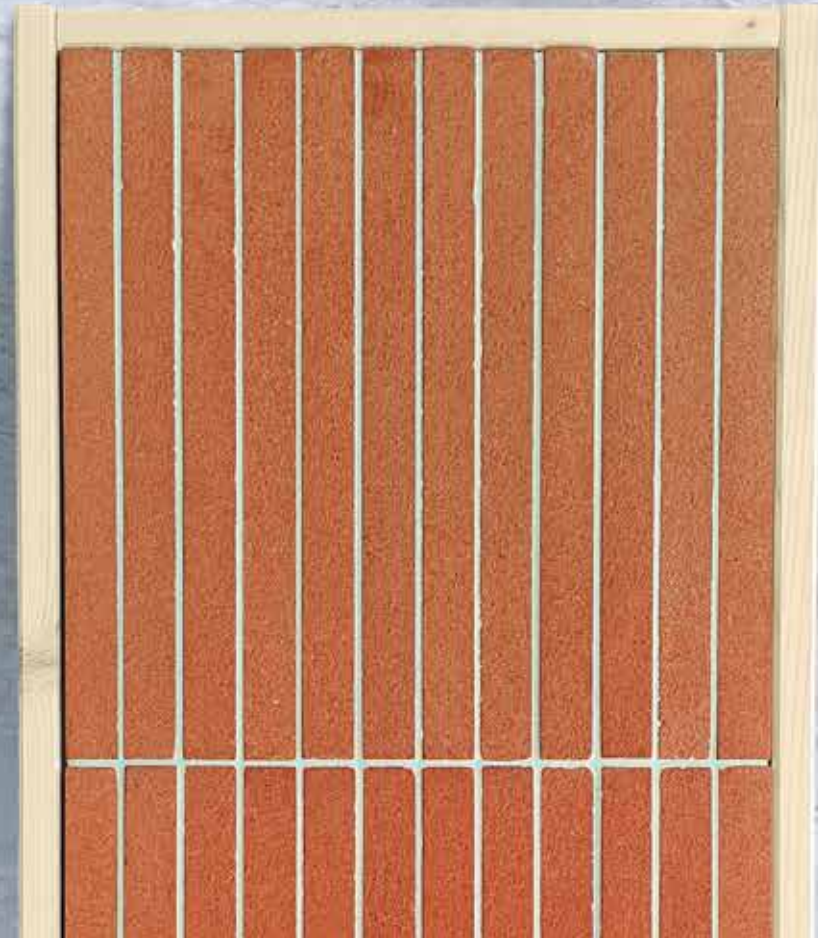



Outdoor | FRG073298000
Bricco_03

LAYOUTS

Corto_01

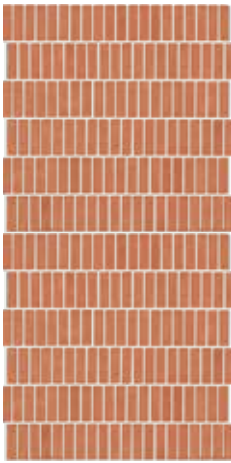

ULTRACOLOR PLUS
103 Moon White

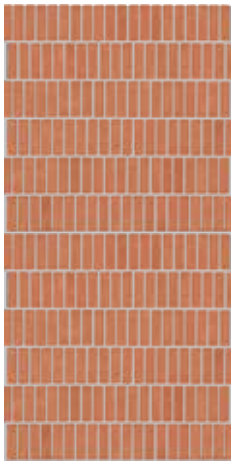

ULTRACOLOR PLUS
111 Silver Grey

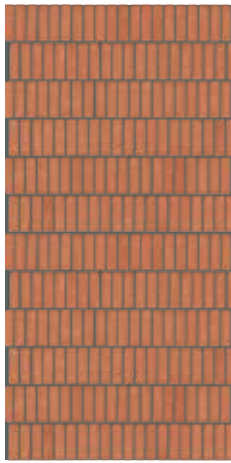

ULTRACOLOR PLUS
174 Tornado

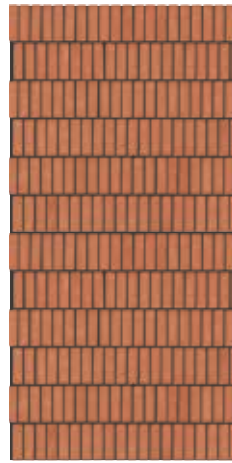

ULTRACOLOR PLUS
120 Black

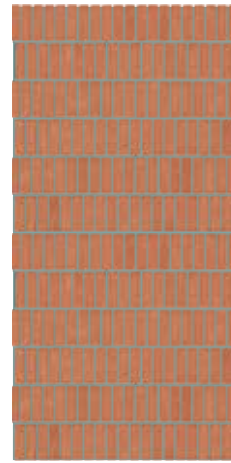

ULTRACOLOR PLUS
177 Sage

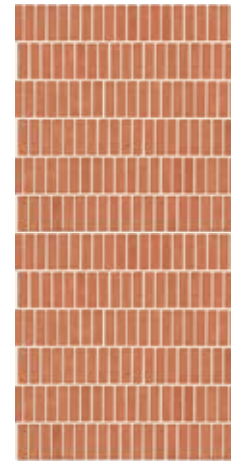

ULTRACOLOR PLUS
130 Jasmine



ULTRACOLOR PLUS
133 Sand

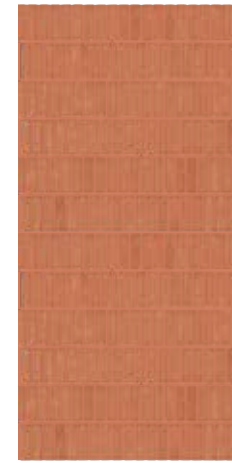

ULTRACOLOR PLUS
154 Terra di Siena

Corto_02

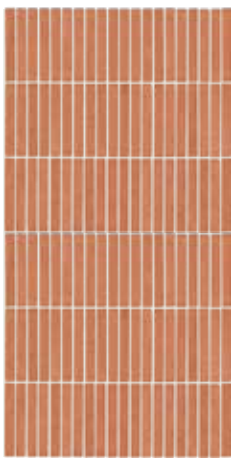

ULTRACOLOR PLUS
103 Moon White

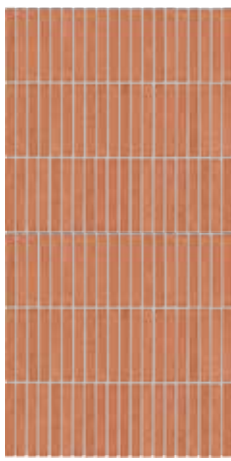

ULTRACOLOR PLUS
111 Silver Grey

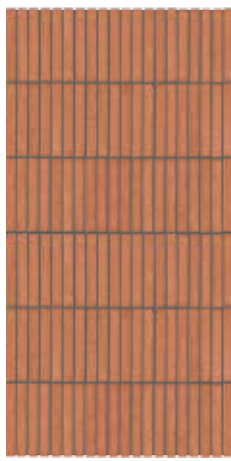

ULTRACOLOR PLUS
174 Tornado

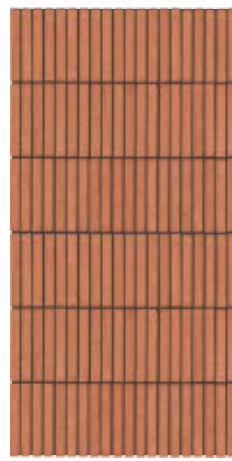

ULTRACOLOR PLUS
120 Black

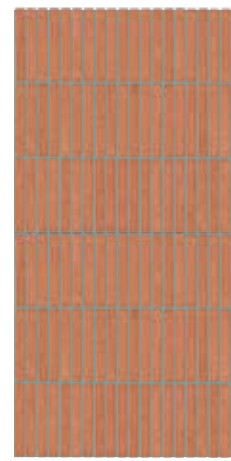

ULTRACOLOR PLUS
177 Sage

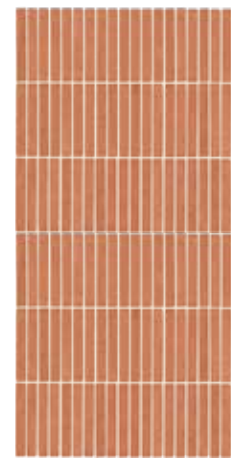

ULTRACOLOR PLUS
130 Jasmine

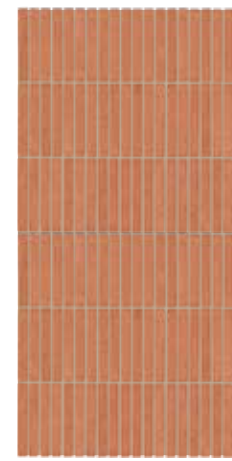

ULTRACOLOR PLUS
133 Sand

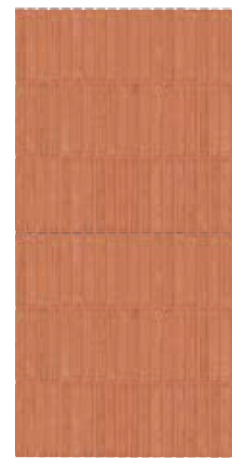

ULTRACOLOR PLUS
154 Terra di Siena

Corto_03

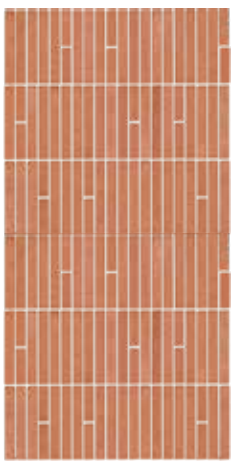

ULTRACOLOR PLUS
103 Moon White

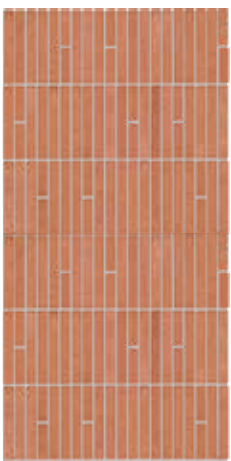

ULTRACOLOR PLUS
111 Silver Grey

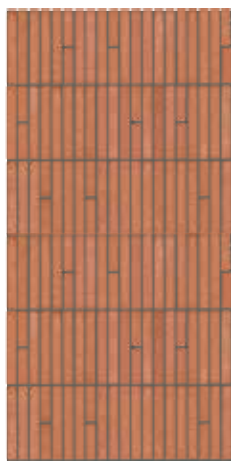

ULTRACOLOR PLUS
174 Tornado

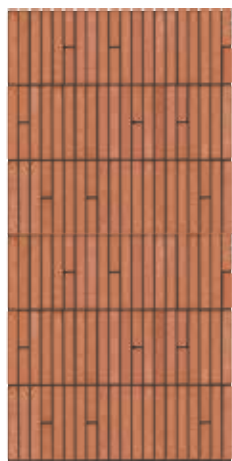

ULTRACOLOR PLUS
120 Black

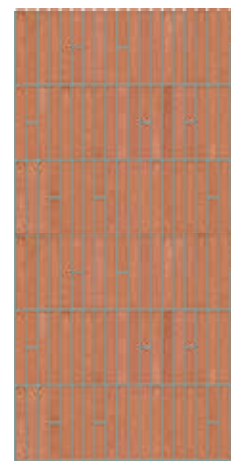

ULTRACOLOR PLUS
177 Sage

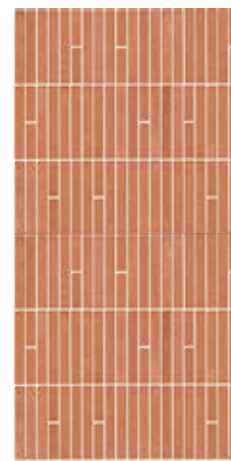

ULTRACOLOR PLUS
130 Jasmine

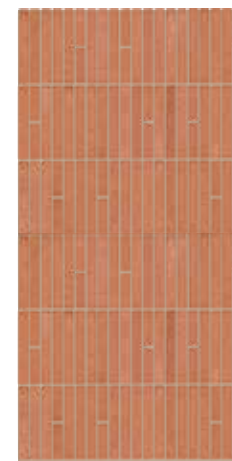

ULTRACOLOR PLUS
133 Sand

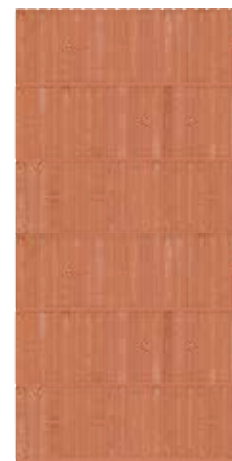

ULTRACOLOR PLUS
154 Terra di Siena

LAYOUTS

Lungo_01

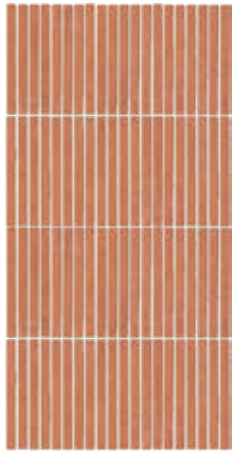

ULTRACOLOR PLUS
103 Moon White

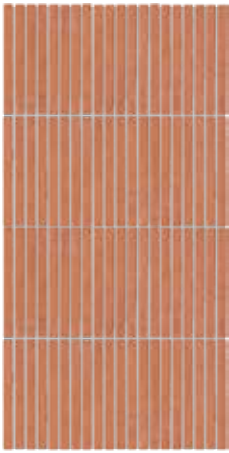

ULTRACOLOR PLUS
111 Silver Grey

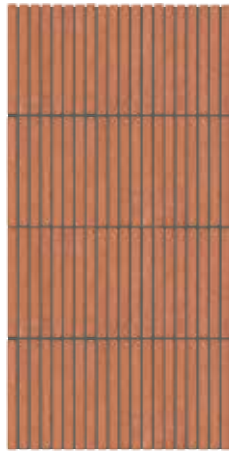

ULTRACOLOR PLUS
174 Tornado

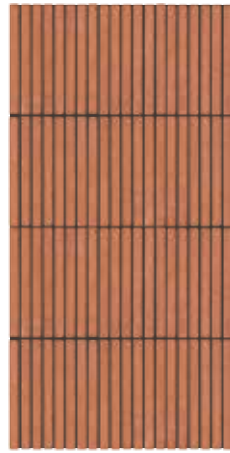

ULTRACOLOR PLUS
120 Black

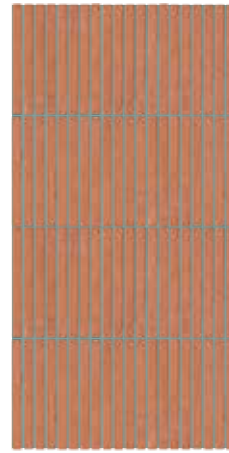

ULTRACOLOR PLUS
177 Sage

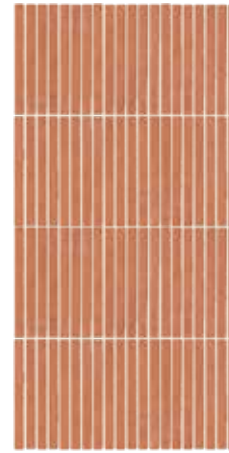

ULTRACOLOR PLUS
130 Jasmine

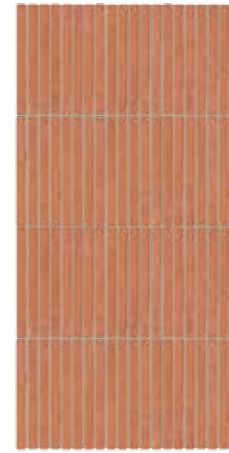

ULTRACOLOR PLUS
133 Sand



ULTRACOLOR PLUS
154 Terra di Siena

Lungo_02

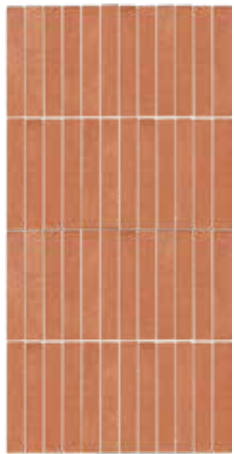

ULTRACOLOR PLUS
103 Moon White

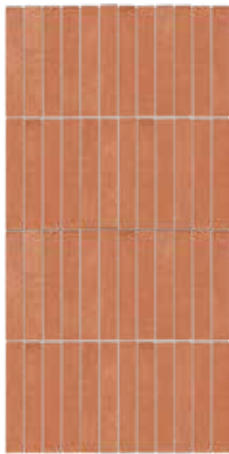

ULTRACOLOR PLUS
111 Silver Grey

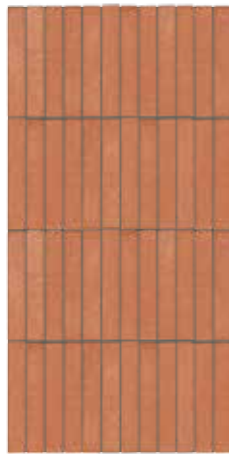

ULTRACOLOR PLUS
174 Tornado

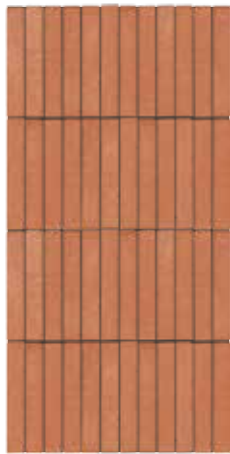

ULTRACOLOR PLUS
120 Black

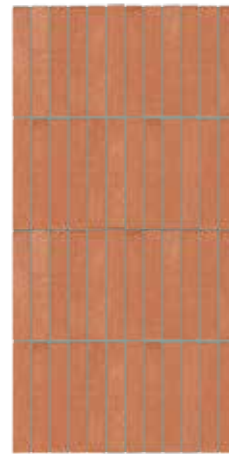

ULTRACOLOR PLUS
177 Sage

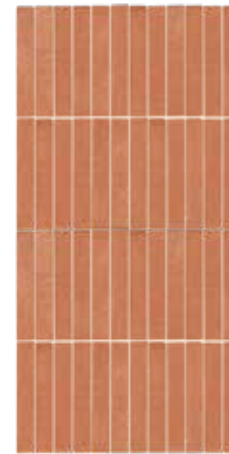

ULTRACOLOR PLUS
130 Jasmine

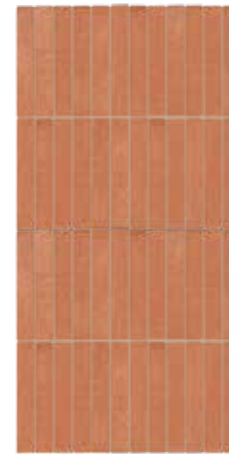

ULTRACOLOR PLUS
133 Sand

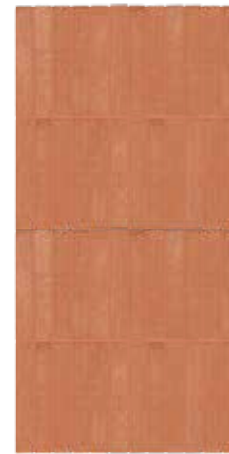

ULTRACOLOR PLUS
154 Terra di Siena

Lungo_03

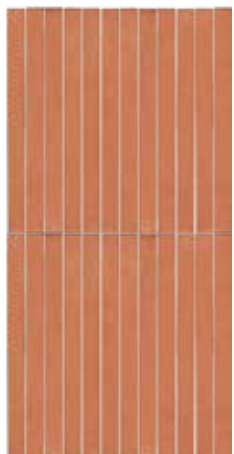

ULTRACOLOR PLUS
103 Moon White



ULTRACOLOR PLUS
111 Silver Grey



ULTRACOLOR PLUS
174 Tornado

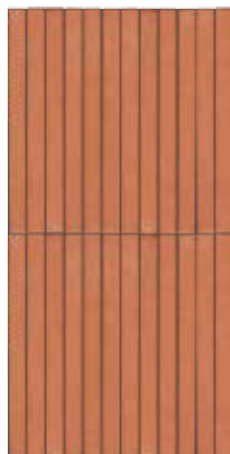

ULTRACOLOR PLUS
120 Black



ULTRACOLOR PLUS
177 Sage

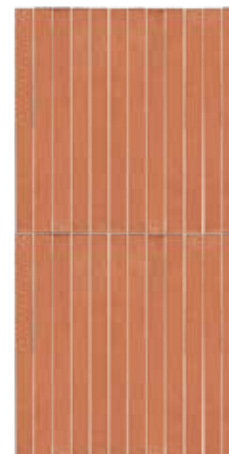

ULTRACOLOR PLUS
130 Jasmine

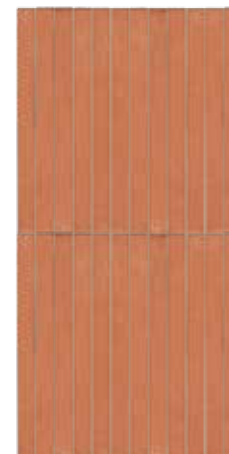

ULTRACOLOR PLUS
133 Sand



ULTRACOLOR PLUS
154 Terra di Siena

LAYOUTS

Bricco_01

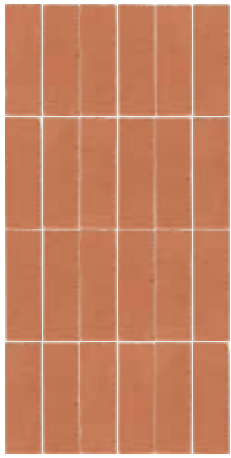

ULTRACOLOR PLUS
103 Moon White

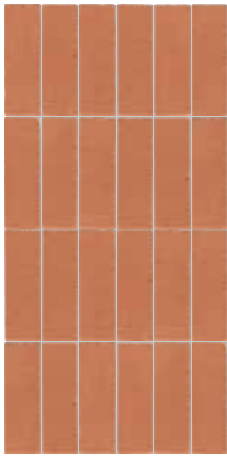

ULTRACOLOR PLUS
111 Silver Grey

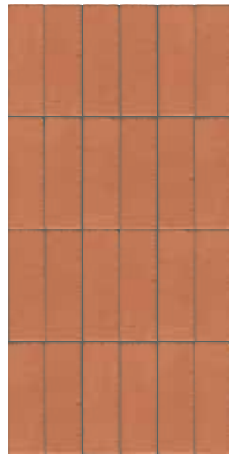

ULTRACOLOR PLUS
174 Tornado

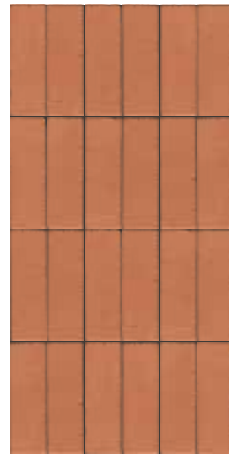

ULTRACOLOR PLUS
120 Black

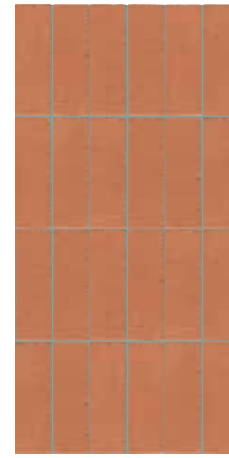

ULTRACOLOR PLUS
177 Sage

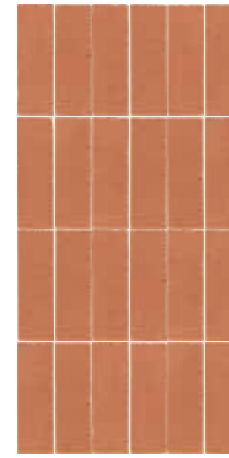

ULTRACOLOR PLUS
130 Jasmine

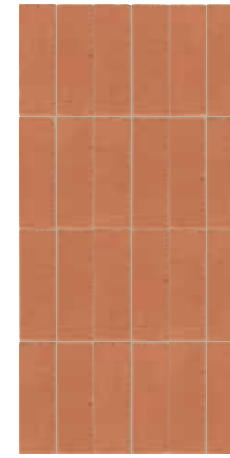

ULTRACOLOR PLUS
133 Sand

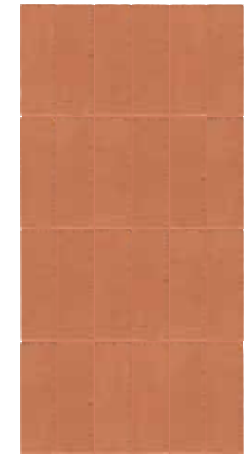

ULTRACOLOR PLUS
154 Terra di Siena

Bricco_02

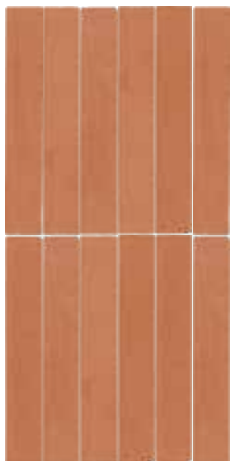

ULTRACOLOR PLUS
103 Moon White

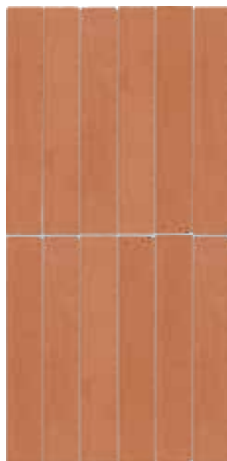

ULTRACOLOR PLUS
111 Silver Grey



ULTRACOLOR PLUS
174 Tornado



ULTRACOLOR PLUS
120 Black

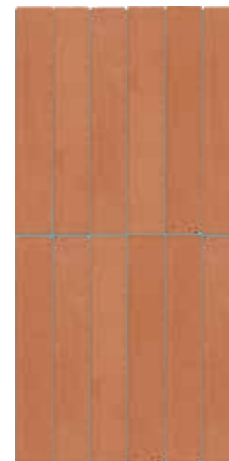

ULTRACOLOR PLUS
177 Sage



ULTRACOLOR PLUS
130 Jasmine



ULTRACOLOR PLUS
133 Sand



ULTRACOLOR PLUS
154 Terra di Siena

Bricco_03



ULTRACOLOR PLUS
103 Moon White



ULTRACOLOR PLUS
111 Silver Grey



ULTRACOLOR PLUS
174 Tornado

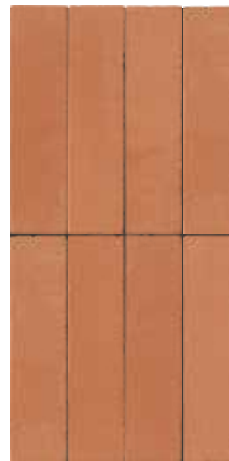

ULTRACOLOR PLUS
120 Black



ULTRACOLOR PLUS
177 Sage



ULTRACOLOR PLUS
130 Jasmine



ULTRACOLOR PLUS
133 Sand



ULTRACOLOR PLUS
154 Terra di Siena

Corto

Moduli | Module



FRG013048000
Corto_01

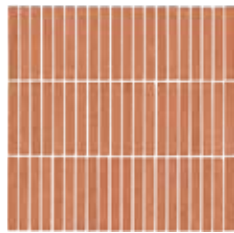

FRG013098000
Corto_02

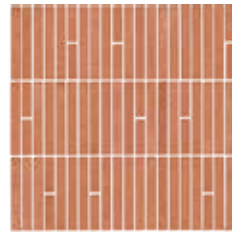

FRG013048098
Corto_03

Dimensioni | Size

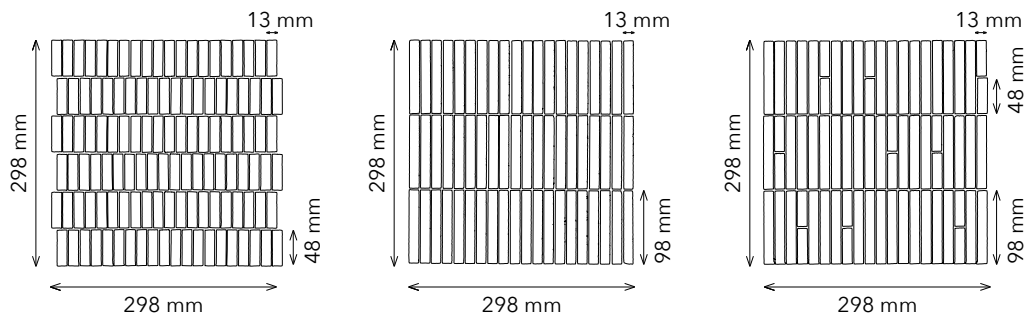

Lungo

Moduli | Module

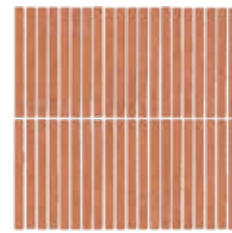

FRG013148000
Lungo_01

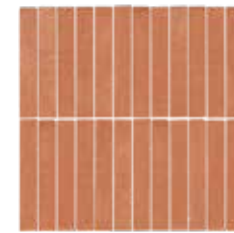

FRG023148000
Lungo_02



FRG023298000
Lungo_03

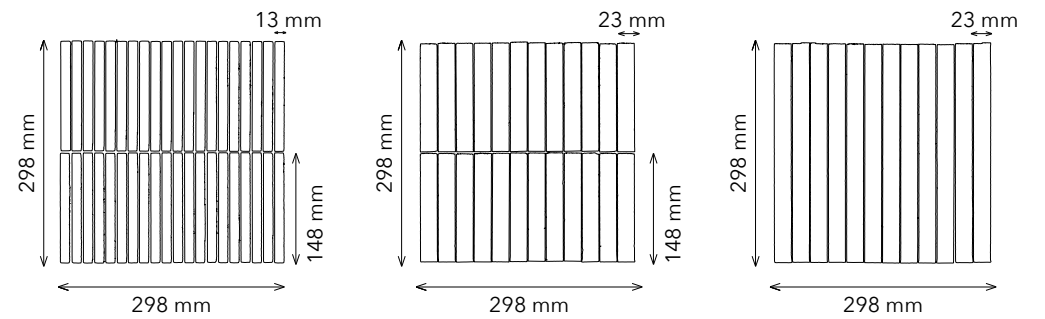

Spessore | Thickness

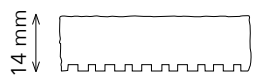

Materiale | Material

Cotto | Terracotta



Wall



Floor

Colore | Colour



ROSSO
IMPRUNETA

Fuga | Joint

2mm

Fugante Cementizio | Cementitious grout

Finitura | Finishing

Naturale | Natural

Superficie | Surface

Arrotata | Brushed

Angoli | Edges

Burattati | Tumbled



Prodotto artigianale. Foto e dettagli tecnici non definiscono i dettagli precisi ed esatti del prodotto.
Le misure riportate nel catalogo sono puramente a scopo indicativo.
Artisan products. Pictures and technical drawings do not define the details of the product.
The measurements shown are indicative only.

Le colorazioni dei prodotti riportati sul catalogo sono da ritenersi puramente indicative e non hanno valore di prova colore.
The colours printed in this catalogue have to be considered merely indicative and have no colour proof value.

Bricco

Moduli | Module

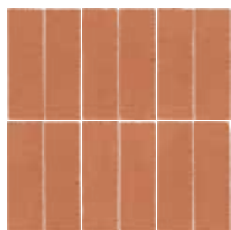

FRG048148000
Bricco_01



FRG048298000
Bricco_02



FRG073298000
Bricco_03

Dimensioni | Size

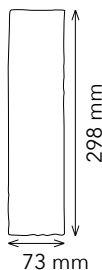
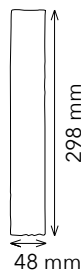
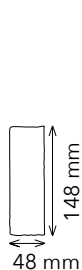

Spessore | Thickness

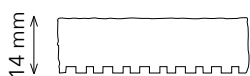

Materiale | Material

Cotto | *Terracotta*



Wall



Floor

Colore | Colour



ROSSO
IMPRUNETA

Profili

Moduli | Module



FRG014020500
Profilo_01



FRG025020500
Profilo_02



FRG014050500
Profilo_03

Dimensioni | Size

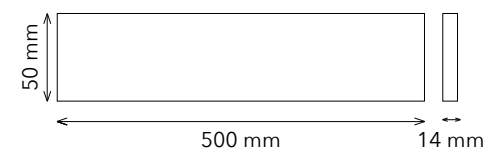
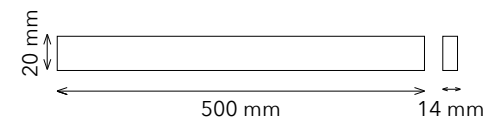

Materiale | Material

Legno massello | *Solid wood*

Colore | Color

Rovere | *Oak*

Finitura | Finishing

Oliato Naturale | *Natural oiled*

Superficie | Surfaces

Spazzolata | *Brushed*

Angoli | Edges

Bisellati | *Microbevelled*













Prodotto artigianale. Foto e dettagli tecnici non definiscono i dettagli precisi ed esatti del prodotto.
Le misure riportate nel catalogo sono puramente a scopo indicativo.
Artisan products. Pictures and technical drawings do not define the details of the product.
The measurements shown are indicative only.

Le colorazioni dei prodotti riportati sul catalogo sono da ritenersi puramente indicative e non hanno valore di prova colore.
The colours printed in this catalogue have to be considered merely indicative and have no colour proof value.

TECHNICAL FEATURES

DIMENSIONAL PROPERTIES	Length (mm)	Width (mm)	Thickness (mm)	Straightness of the edges	Orthogonality	Flatness
Norm UNI EN ISO 10545-2	± 1,5%	± 1,5%	± 10%	± 1,0%	± 1,0%	± 1,5%

(1) Dimensional tolerances have to be intended for the same lot of production
The section of the tile does not allow the execution of the test. Typical value of the material 20 N / mm²

COMMON FEATURES	NORM	OUTCOME
 Water absorption	UNI EN ISO 10545-3	7%
 Deep abrasion resistance	UNI EN ISO 10545-6	544 mm ³
 Thermal linear expansion	UNI EN ISO 10545-8	5,8 (10 ⁻⁶ /°C)
 Thermal shock resistance	UNI EN ISO 10545-9	Resistent
 Expansion to humidity in boiling water	UNI EN ISO 10545-10	0,01 mm/m
 Frost resistance	UNI EN ISO 10545-12	Resistent
 Chemical resistance	UNI EN ISO 10545-13	Resistent
 Stain resistance	UNI EN ISO 10545-14	Removable stains
 Slip resistance	DIN 51097	> 35°
 Anti Slip properties	DIN 51130	> 35° - R13
 Mohs' hardness	UNI EN 101	6

PACKAGING

CODE	NAME	PC/BOX	SQM/BOX	Kg/BOX	BOX/plt	SQM/plt	Kg/plt
FRG013048000	Corto_01	6	0,53	13	42	22,26	597
FRG013098000	Corto_02	6	0,53	13	42	22,26	597
FRG013048098	Corto_03	6	0,53	13	42	22,26	597
FRG013148000	Lungo_01	6	0,53	13	42	22,26	597
FRG023148000	Lungo_02	6	0,53	13	42	22,26	597
FRG023298000	Lungo_03	6	0,53	13	42	22,26	597
FRG048148000	Bricco_01	72	0,51	13,5	60	30,6	810
FRG023148000	Bricco_02	36	0,51	13,5	60	30,6	810
FRG073298000	Bricco_03	24	0,52	13,5	60	31,2	810

CODE	NAME	PC/BOX	LM/BOX	Kg/BOX
FRG014020500	Profilo_01	8	4	1,5
FRG025020500	Profilo_02	8	4	2
FRG014050500	Profilo_03	6	3	3

INSTALLATION AND CARE

IT/

INSTALLAZIONE

Raccomandiamo di installare Fragmenti Cotto utilizzando un adesivo cementizio ad alte prestazioni con scivolamento verticale nullo. Per una soluzione di continuità di posa suggeriamo di posare le piastrelle o i singoli fogli di mosaico con 2 mm di fugante cementizio. Per installazioni in pareti a diretto contatto con l'acqua è consigliabile proteggere il supporto con un'adeguata membrana impermeabile.

A stuccatura ultimata e completamente asciutta la superficie deve essere lavata con acido fosforico tamponato diluito (15-20%) con acqua FRAGMENTI EASYCLEANER. La pulizia finale è un'operazione molto importante per assicurare un ottimo risultato tecnico ed estetico durante le varie fasi di trattamento finale. Per pulire ogni residuo di stucco, collante o carbonato di calcio, la soluzione di acido tamponata deve lavorare sulla superficie per un massimo di 2-3 minuti. Esposizioni più prolungate possono modificare o danneggiare l'aspetto del fugante cementizio. Risciacquare accuratamente la superficie prima che la soluzione di acido tamponato possa asciugarsi in superficie. Controllare con attenzione di aver rimosso tutte le tracce di collante, stucco e carbonato di calcio dalla superficie. Se il risultato non dovesse essere soddisfacente, prima di procedere con il trattamento finale, consigliamo di ripetere le operazioni di pulizia aumentando la percentuale di acido nella soluzione detergente.

TRATTAMENTI

Per installazioni in pareti a diretto contatto con l'acqua raccomandiamo di proteggere la superficie con due strati di FRAGMENTI EASYCARE. Si tratta di un protettivo naturale che crea una membrana idro-oleorepellente senza alterare l'aspetto naturale della superficie del prodotto. FRAGMENTI EASYCARE è il risultato di attente ricerche e si avvale di una nuova generazione di copolimeri acrilici fluorurati silanici con caratteristiche idro-oleorepellenti uniche per la protezione dei materiali da costruzione. Garantisce una durata superiore e un'ottima protezione del supporto trattato. È un prodotto di facile applicazione con l'utilizzo di spandicera, strofinaccio di cotone, pennello o irroratore a bassa pressione. Su superfici verticali applicare il prodotto bagnato su bagnato, su pavimentazioni invece attendere 30-60 minuti tra una applicazione e l'altra. Per installazioni a pavimento raccomandiamo di completare il trattamento con FRAGMENTI EASYWAX. FRAGMENTI EASYWAX è una speciale cera protettiva opaca di manutenzione straordinaria da utilizzare 24 ore dopo il trattamento con FRAGMENTI EASYCARE. FRAGMENTI EASYWAX con la sua speciale formula ha il pregio di apportare una maggiore protezione alle superfici trattate senza alterare il tono naturale delle superfici e, nel contempo, semplifica le operazioni di manutenzione ordinaria. Suggeriamo di applicare due strati di FRAGMENTI EASYWAX utilizzando uno strofinaccio di cotone o un pennello. Raccomandiamo di aspettare 2 ore tra la prima e la seconda applicazione.

CURA e PULIZIA

Per la pulizia ordinaria suggeriamo di utilizzare detersivi neutri. Non usare alcoli, detersivi a base acida, solvente o ammoniacale.

Installazioni a pavimento hanno bisogno, a seconda dell'usura, di un periodico ravvivamento della finitura (ogni 12-24 mesi) con l'applicazione di uno strato di FRAGMENTI EASYWAX puro o diluito al 50% in acqua.



Resa: con 5 litri di soluzione diluita si possono lavare circa 10-20 mq di superficie



Resa: Un litro di prodotto copre (1 strato) circa 15-25 mq di superficie



Resa: Un litro di prodotto copre (1 strato) circa 25-35 mq di superficie

EN/

INSTALLATION

We suggest to install our *Fragmenti Cotto* using a high-performance cementitious adhesive with no vertical slip. For a seamless solution we suggest to lay the tiles and mosaic sheets with 2 mm of joint. The grouting of the joint must be completed using cementitious grouts. For walls in direct contact with water we recommend to create an appropriate waterproof membrane on the substrate. After grouting and only when the "package" is completely dry, the surfaces must be cleaned with buffered phosphoric acid diluted (15-20%) with water (*FRAGMENTI EASYCLEANER*). The cleaning is a very important operation in order to ensure optimum results during the final treatment. In order to dissolve effectively all traces of grout, adhesive, lime and calcium residues, the acid solution must be left on the surface for maximum 2-3 minutes. Longer exposition could modify and damage the cement grouting mortar in the joints. Rinse the surface thoroughly (until the water runs off clean), and before it has time to dry after being cleaned with acid. Be sure to remove all traces of grout, adhesive, lime and calcium from the surface. If the outcome is not satisfactory you could repeat the cleaning operation, slightly increasing the percentage of the acid in the solution.

TREATMENTS

For walls in direct contact with water we recommend to protect the surface with 2 layers of our *FRAGMENTI EASYCARE*. It is one-step natural sealer which create a hydro oil repellent membrane on the product

surface without changing the natural looking of the material. *FRAGMENTI EASYCARE* is the result of careful research using a new generation of silane fluorinated acrylic copolymers with unique hydro oil repellent characteristics, for the protection of surface materials. It guarantees a longer duration of the product and excellent protection of the treated support. It is very easy to apply with spreader fleece, cotton cloth or brush. On vertical surfaces apply the product wet on wet, on floors instead wait 30-60 minutes between the first and second application.

For Floor Installations we recommend to complete the treatment with *FRAGMENTI EASYWAX*. *FRAGMENTI EASYWAX* is a special matt protective wax to be used after 24 hours of the *FRAGMENTI EASYCARE* treatment. *FRAGMENTI EASYWAX* with its special formula has the advantage of providing greater protection to surface treated without altering the natural effect of the surface and, at the same time, simplifies routine maintenance operations. We suggest to finish the surface with two coats of *FRAGMENTI EASYWAX*, applied with the aid of a cotton cloth or brush, taking care to spread a thin veil. We recommend to wait 2 hours between the first and second application.

MAINTENANCE

For normal and routine cleaning purposes, we recommend to use neutral detergents. Do not use alcohols, acid-based, solvent or ammonia based cleaners.

Floor installations needs to be freshened up periodically, depending on the level of wear and tear, with *FRAGMENTI EASYWAX* applied pure or diluted 50% with water.



YIELD: with 5 liters of diluted solution are washed about 10-20 sqm of surface



YIELD: Approximately 15-25 sqm/l per coat.



YIELD: Approximately 25-35 sqm/l per coat.

Credits



GIACOBAZZI

D-SEGNO
STUDIO

NIC

AN·TRAX IT



Colophon

Art Direction: D-Segno Studio
Graphic Design: D-Segno Studio

Via Caula, 18/A
41049 Sassuolo(MO) - Italy T.
+39 348.8744890
P.iva 02651960359
info@d-segno.com
d-segno.com



We Are



FRAGMENTI



FRAGMENTI s.r.l.
Via Giardini 464/N1
41124 Modena, ITALY
info@fragmenti.it

All rights reserved. Not any part
of this work can be reproduced
in any way without the written
authorizathion by FRAGMENTI.

www.fragmenti.it

